



AMAP Colloquium

***Aluminium markets –
current developments and
challenges***

Dr. Andreas Postler
Head of Economics and Statistics

Presentation

4

April
2019





GESAMTVERBAND DER
ALUMINIUMINDUSTRIE e.V.

Aluminium markets – current developments and challenges

Contents

1. Introduction
2. Motivation
3. European demand for semi-fabricated products
4. Aluminium trade
5. Summary



GESAMTVERBAND DER
ALUMINIUMINDUSTRIE e.V.

Aluminium markets – current developments and challenges

Contents

1. Introduction
2. Motivation
3. European demand for semi-fabricated products
4. Aluminium trade
5. Summary



Aluminium markets in Germany

Consumption by end-use

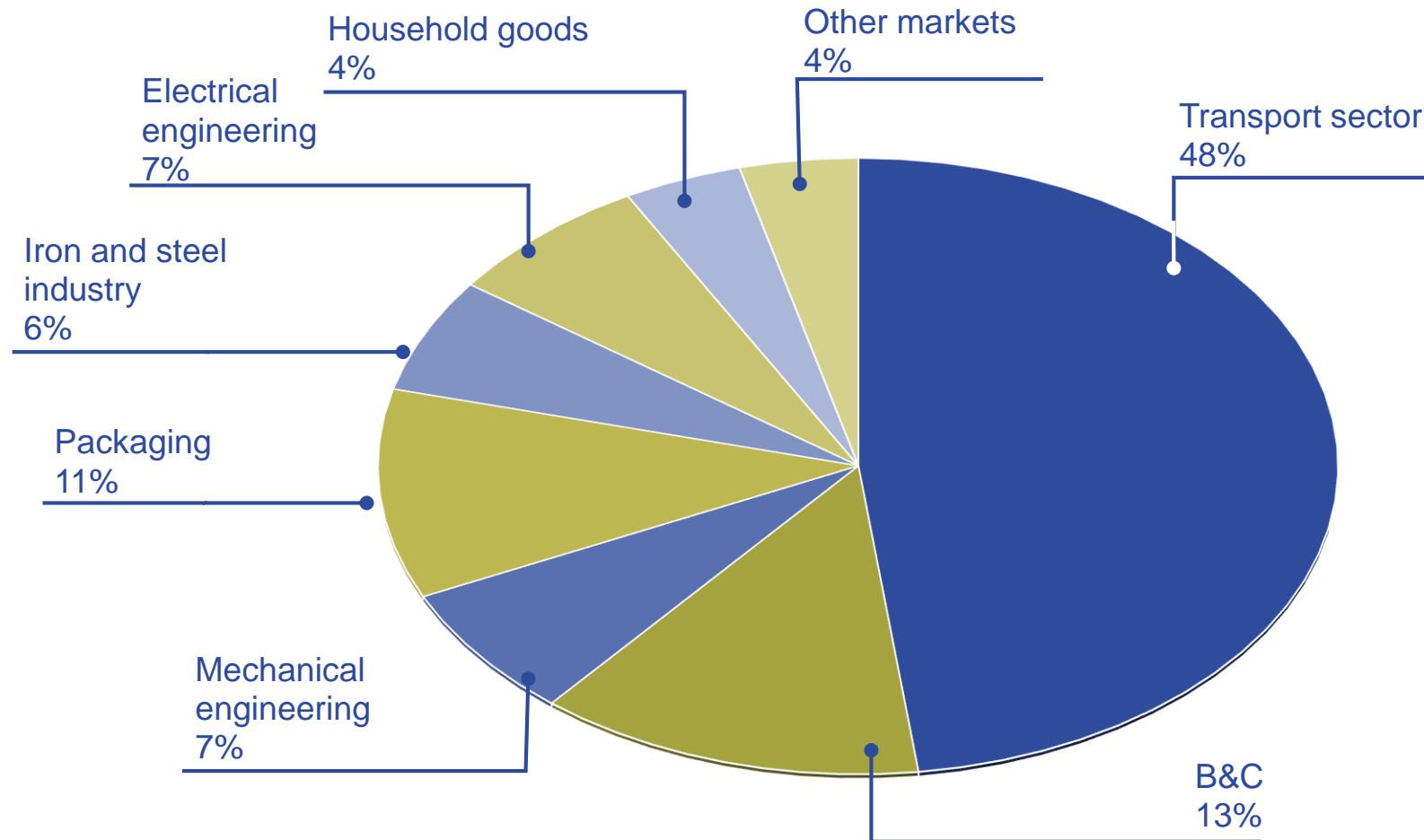



Why aluminium?

Properties

1

Light

2

Strong

3

Long Lasting

4

Ductility

5

Conductivity

6

Corrosion resistant

7

Reflective

8

100% Recyclable

Opportunities for growth

Mega trends

- 1 Demographic change
- 2 Urbanization
- 3 Climate Change
- 4 Resource Scarcity
- 5 Increasing Mobility



Total Passenger Cars | New Car Registrations

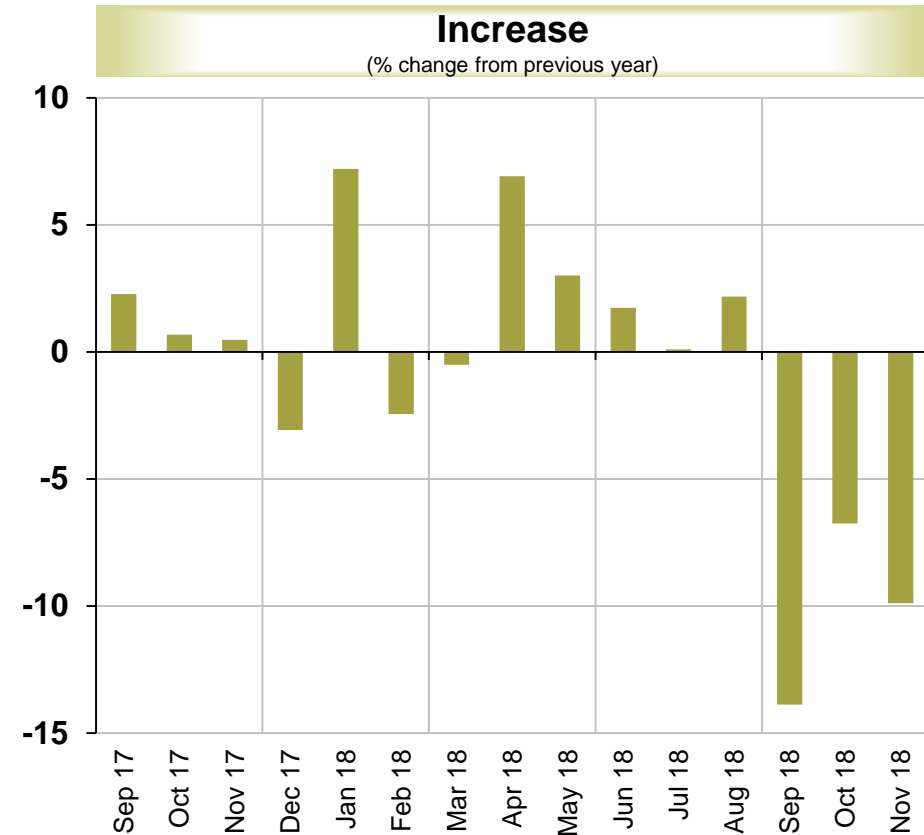
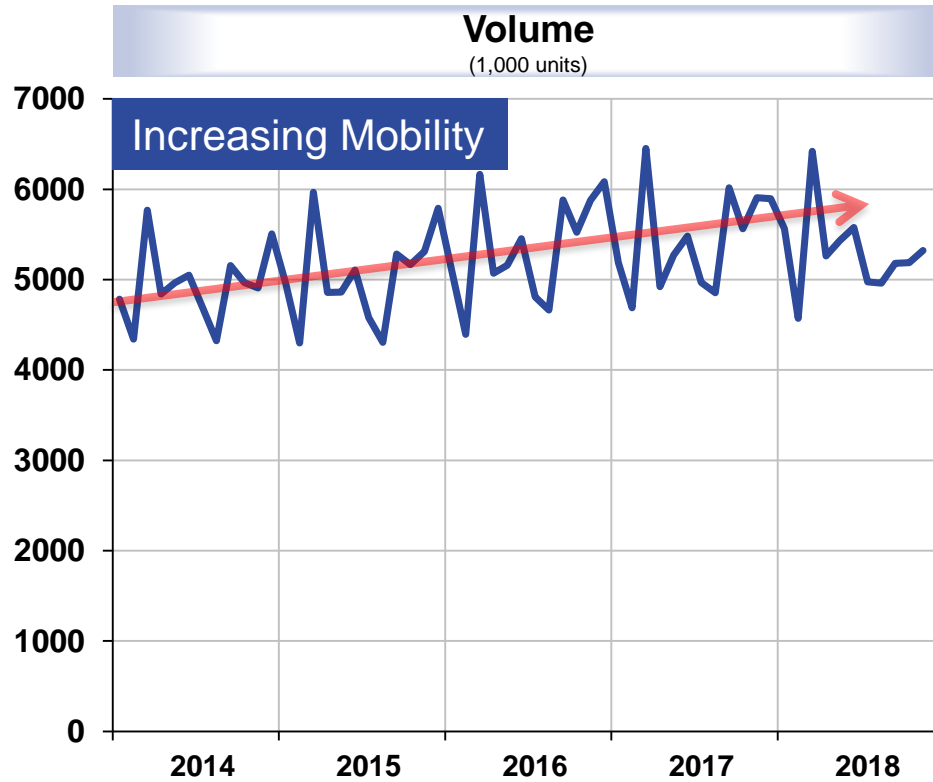

59,292 4.0 %	60,475 2.0 %	64,171 6.1 %	65,212 1.6 %	58,451 * - 1.5 %*

17,485 1.1 %	16,031 0.4 %	17,114 2.8 %	15,511 1.3 %	15,690 - 10.3 %

* 01 - 11

Global megatrends

Population growth

Region	Population			
	2015		2100	
	million	%	million	%
World	7.349	100	11.213	100
Africa	1.186	16	4.387	39
Asia	4.393	60	4.889	44
Europe	738	10	646	6
Latin America	634	8	721	6
North America	358	5	500	4
Oceania	39	1	71	1

Global vehicle density 2014 is highly unequally distributed

Region	registered vehicles	vehicles pro 100 residents	residents in million
World	1.012	15	6.887
Africa	26	3	1.027
Asia	269	7	4.040
Europe	324	40	813
Americia	377	39	970
Oceania	16	44	37



GDA simulation of the global vehicle fleet

Region	Global vehicle fleet	
	2015	2100
	million	million
World	1.012	1.996
Africa	26	558
Asia	269	661
Europe	324	283
Americia	377	464
Oceania	16	30

Result:

The global vehicle fleet might double till 2100.
The fleet in Europe might decline!

The new AUDI A 6

Materials in the body structure

Audi A6

Karosseriematerialien
Materials in the body structure

01/11



-  **Aluminiumblech**
Sheet aluminium
-  **Aluminiumguss**
Cast aluminium
-  **Aluminiumprofil**
Aluminium sections
-  **Stahl warmumgeformt**
Hot-formed steel
-  **Stahl kaltumgeformt**
Cold-formed steel

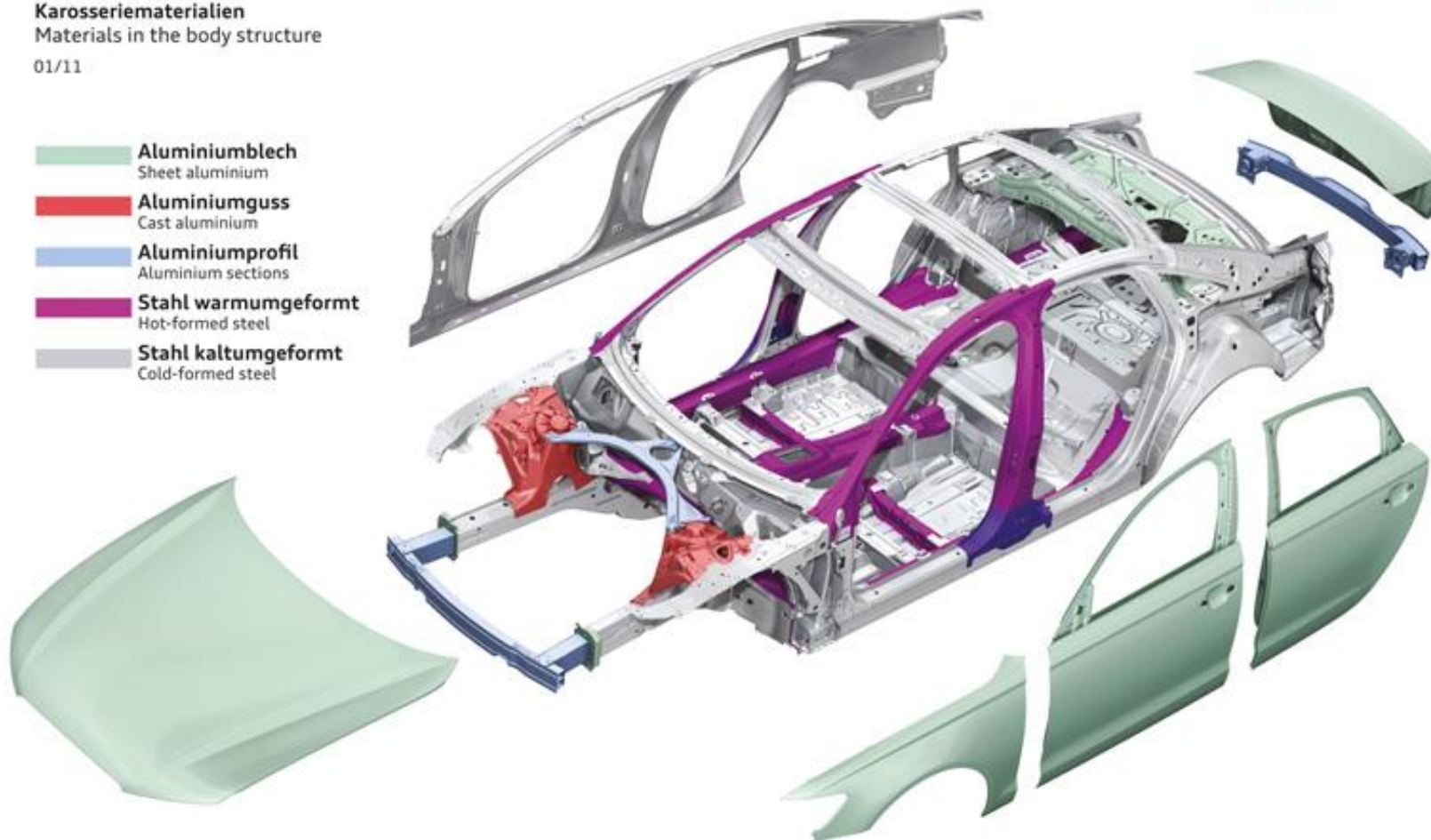

AUDI TT Coupé 2014

Materials in the body structure



Audi TT Coupé

Karosseriematerialien
Materials in the body structure

03/14

-  **Ultrahochfeste Stähle (warmumgeformt)**
Ultra-high strength steels (hot-formed)
-  **Konventionelle Stähle**
Conventional steels
-  **Aluminium-Profil**
Aluminum section
-  **Aluminium-Blech**
Aluminum sheet
-  **Aluminium-Guss**
Aluminum castings

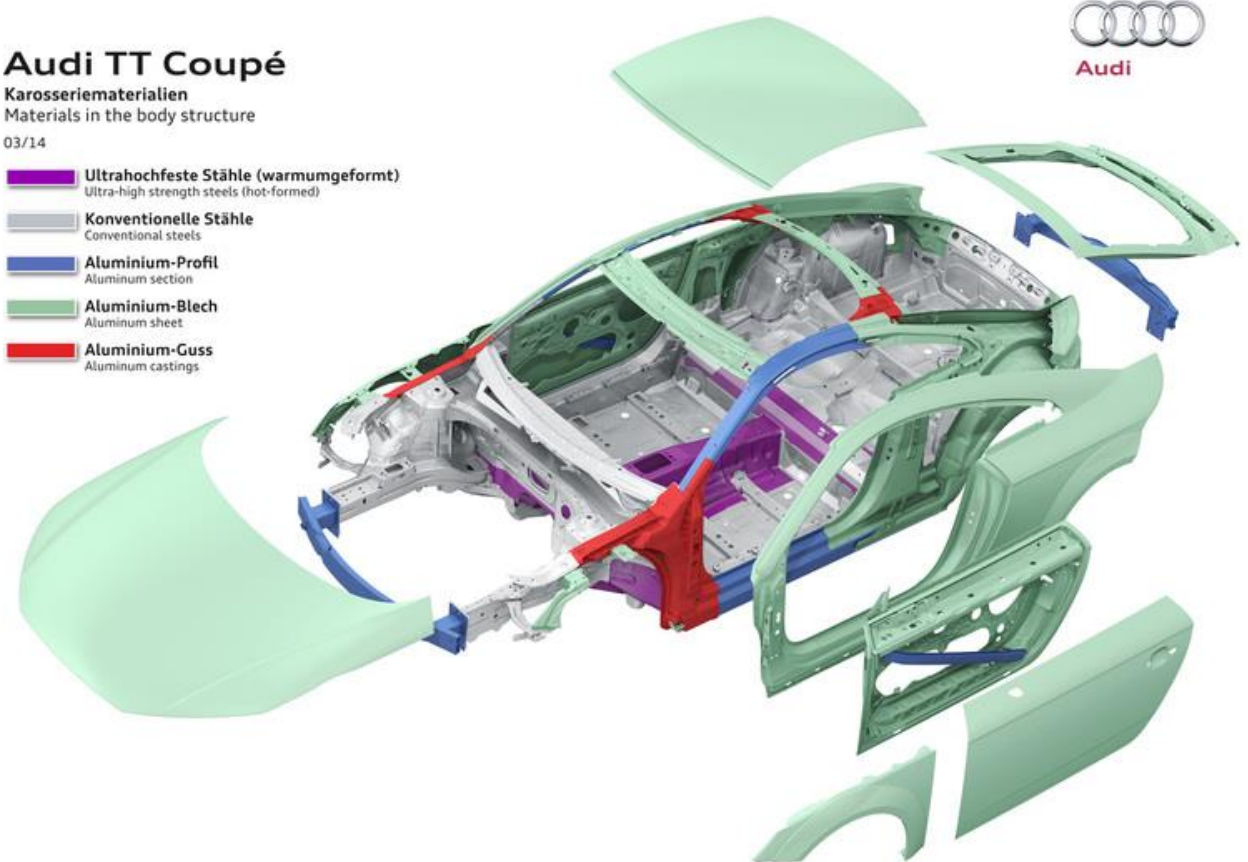

European passenger car Aluminium share (estimated)

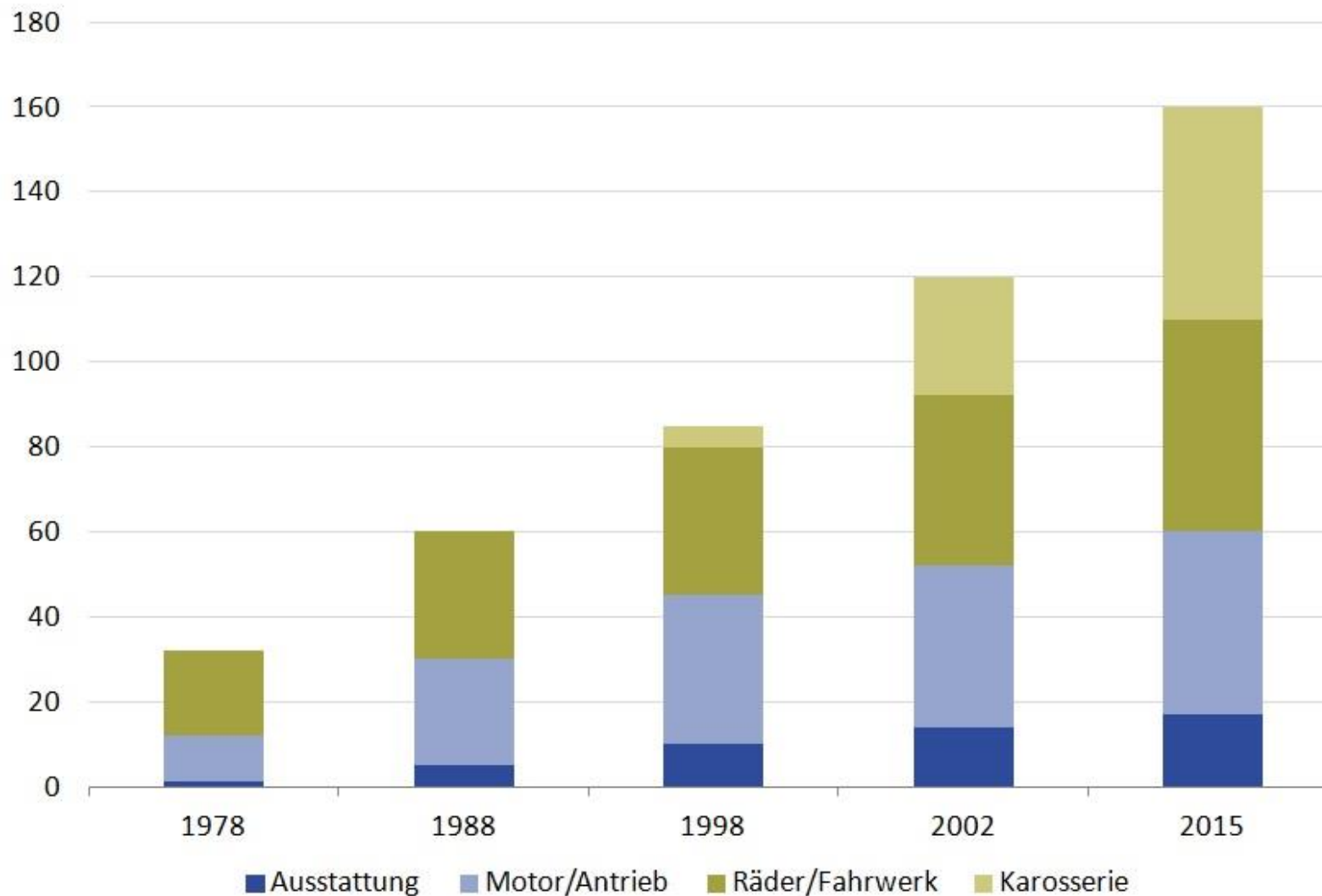



Automotive materials

Development of the aluminium volume

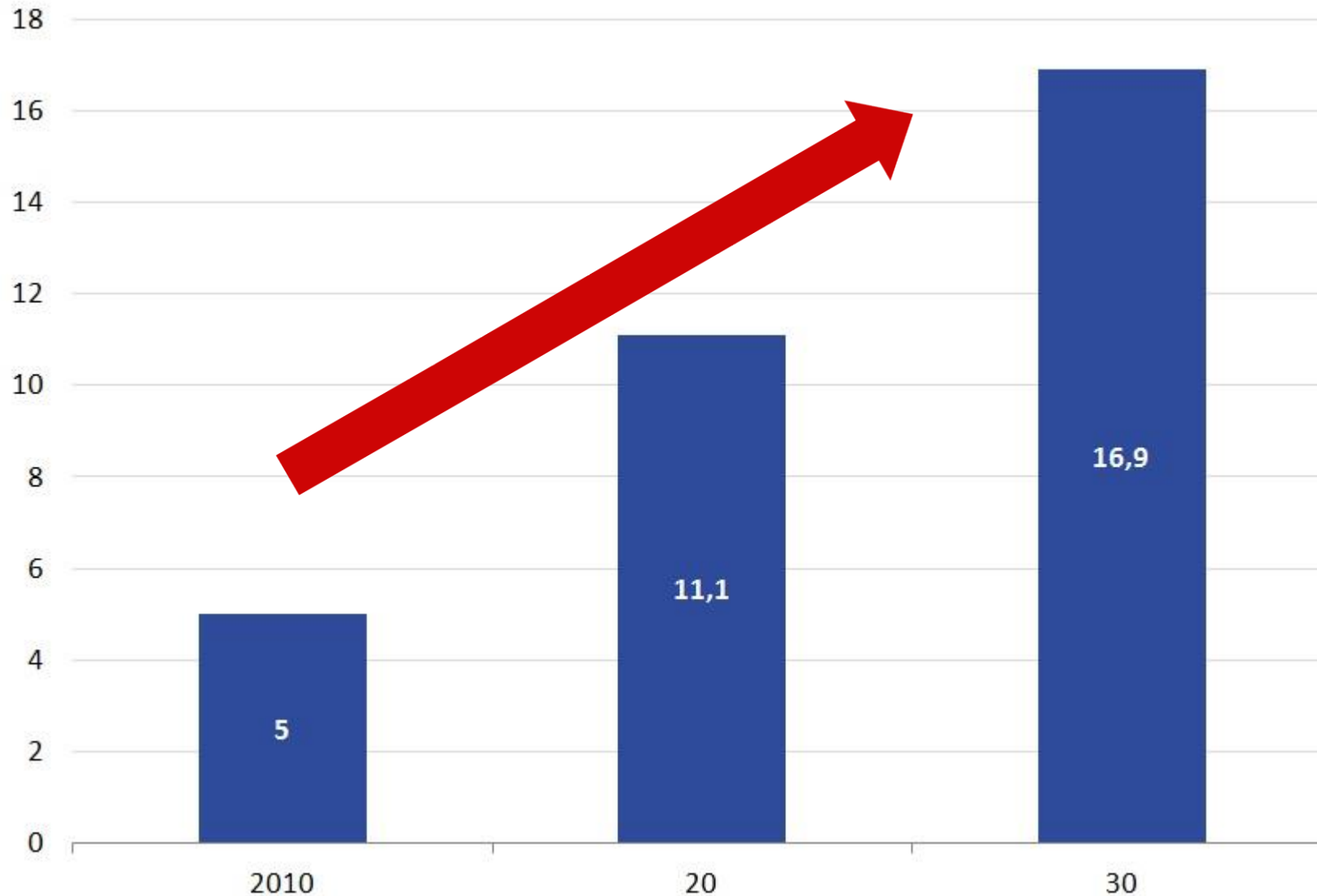

Additional demand
of more than
10 million
tonnes

Aluminium net pounds per North American light vehicle

Development from 1985 to 2025

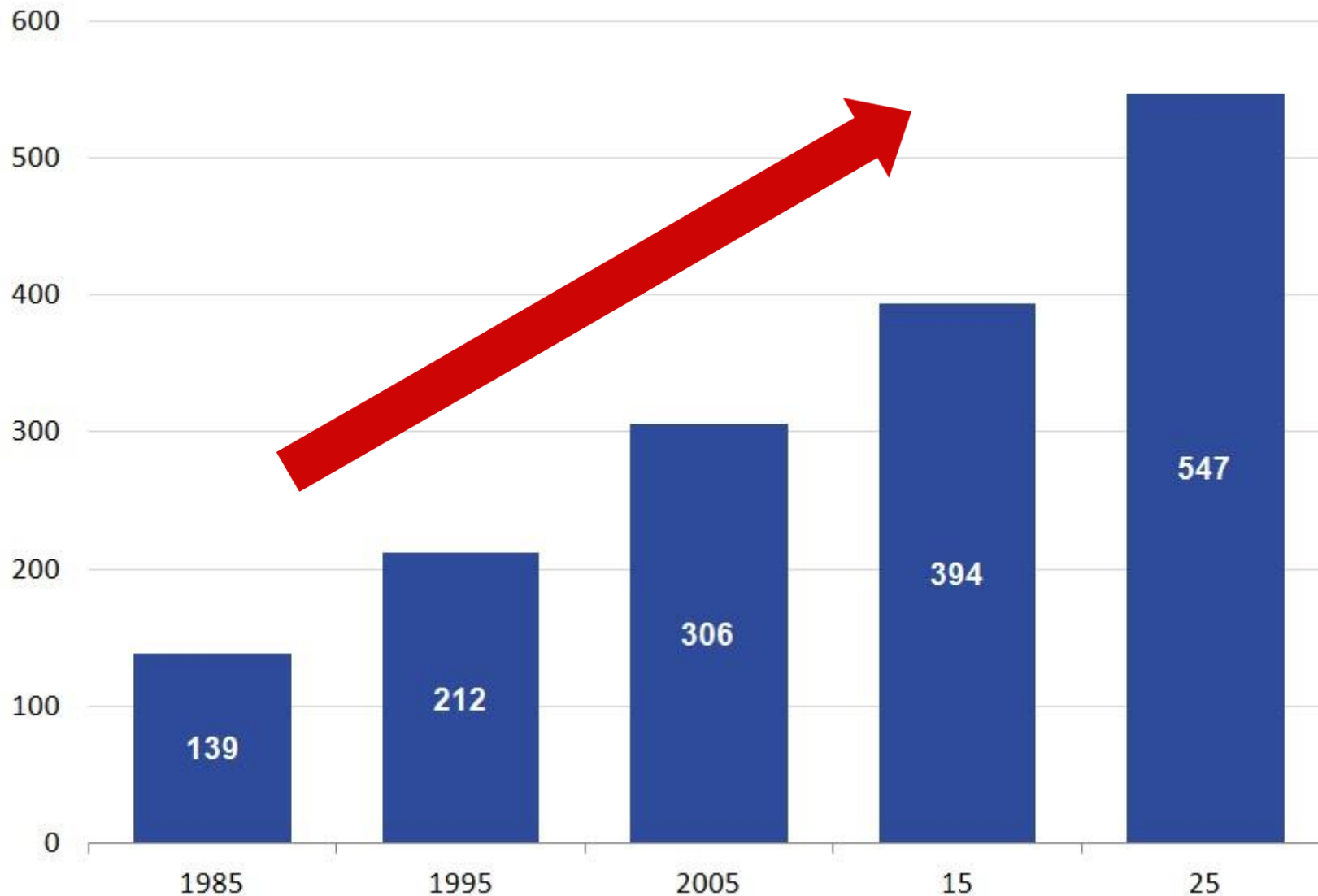



GESAMTVERBAND DER
ALUMINIUMINDUSTRIE e.V.

Aluminium markets – current developments and challenges

Contents

1. Introduction
2. Motivation
3. European demand for semi-fabricated products
4. Aluminium trade
5. Summary

EU Economic Situation

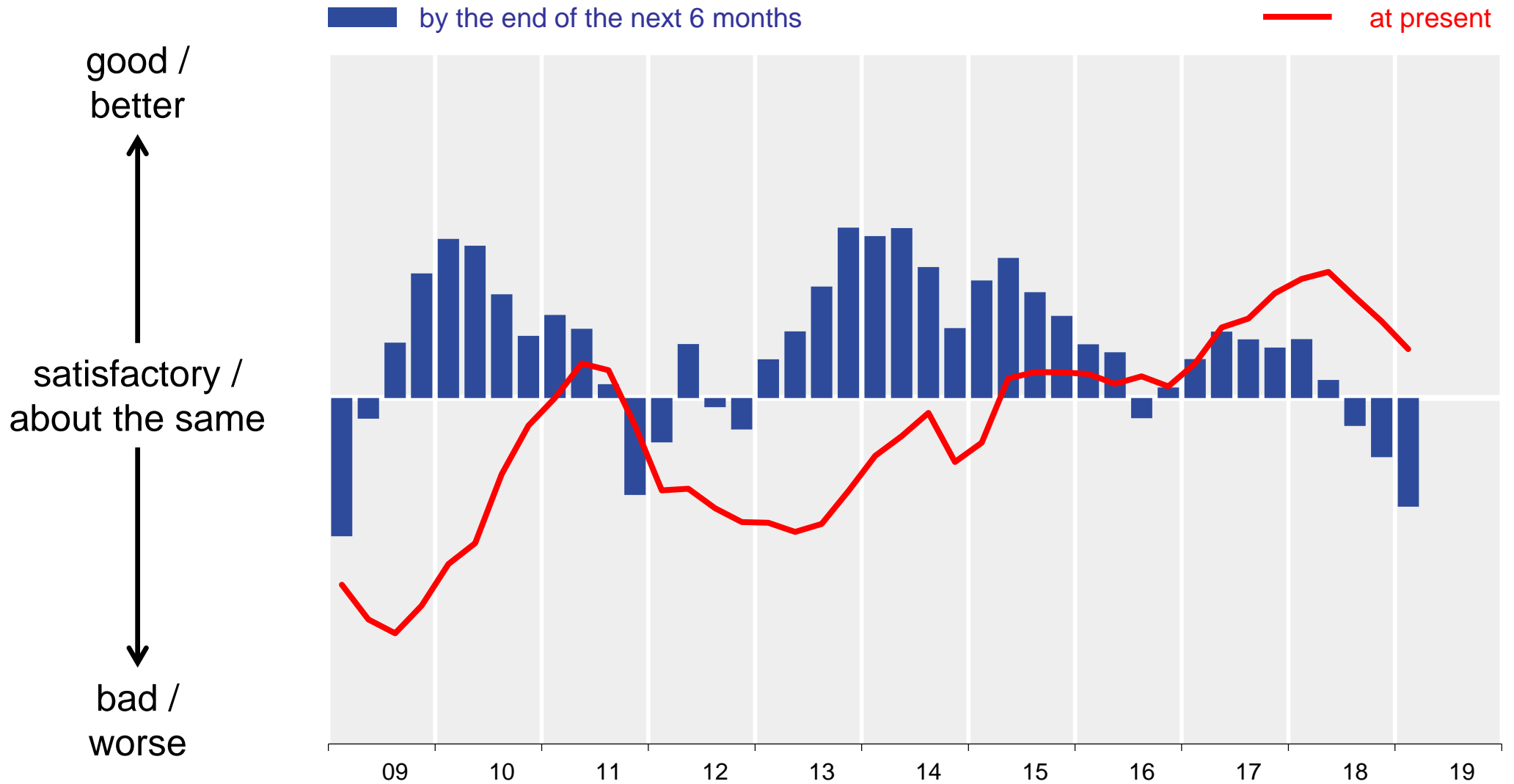

Europe

Macroeconomic framework in the Euro zone

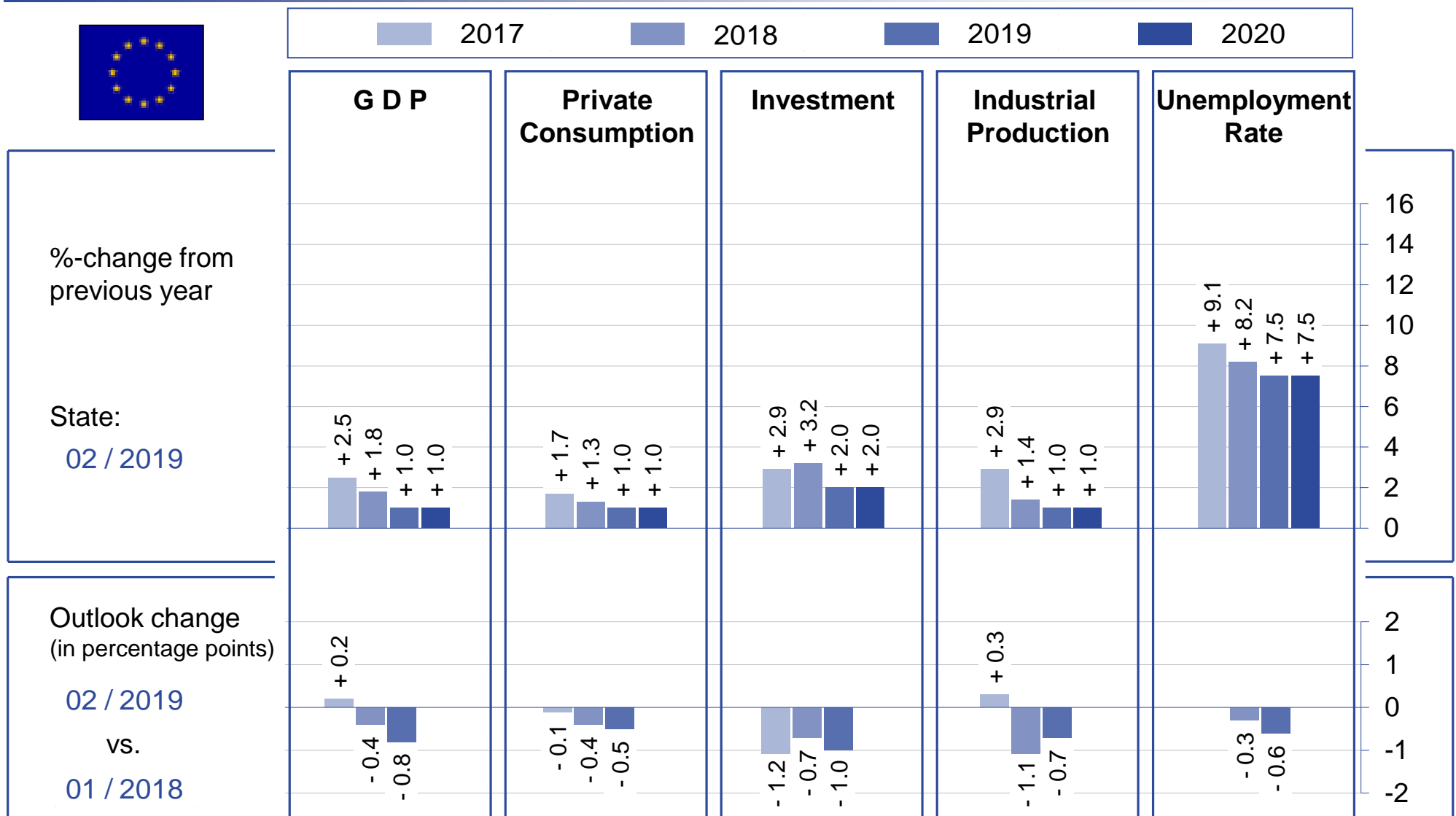



EU 15 (Belgium & Sweden estimates by GDA)

Passenger Cars | Production | Forecast

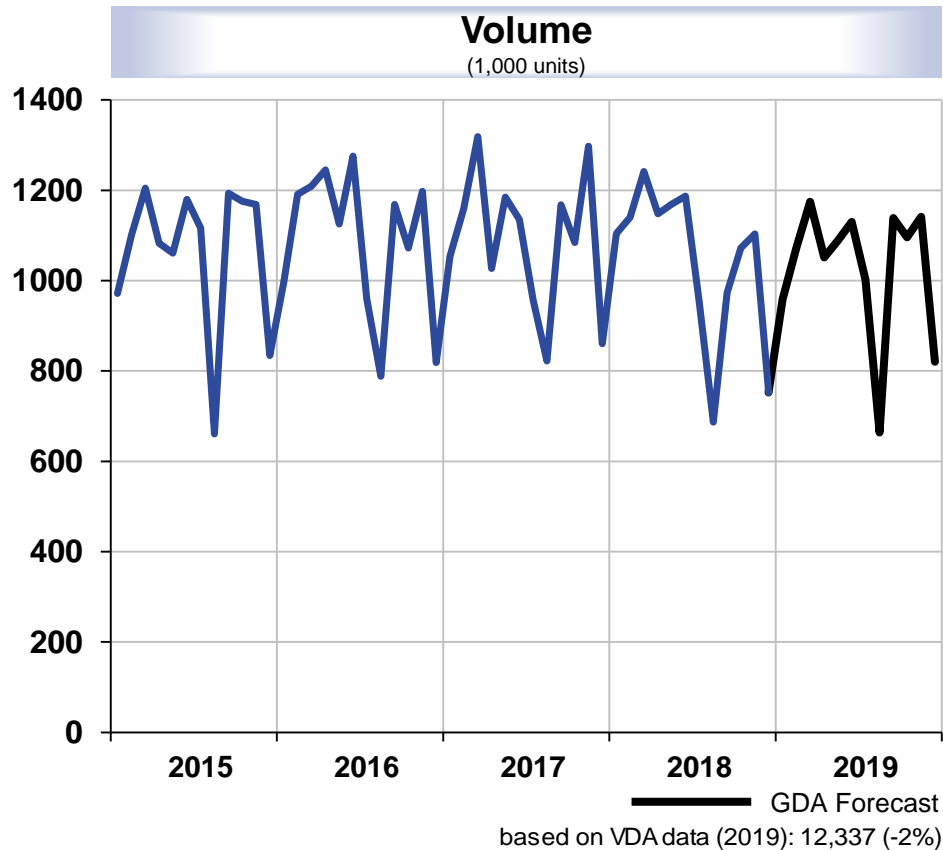

12,750	13,048	13,069	12,531	12,337
6.9 %	2.3 %	0.2 %	- 4.1 %	- 2.0 %

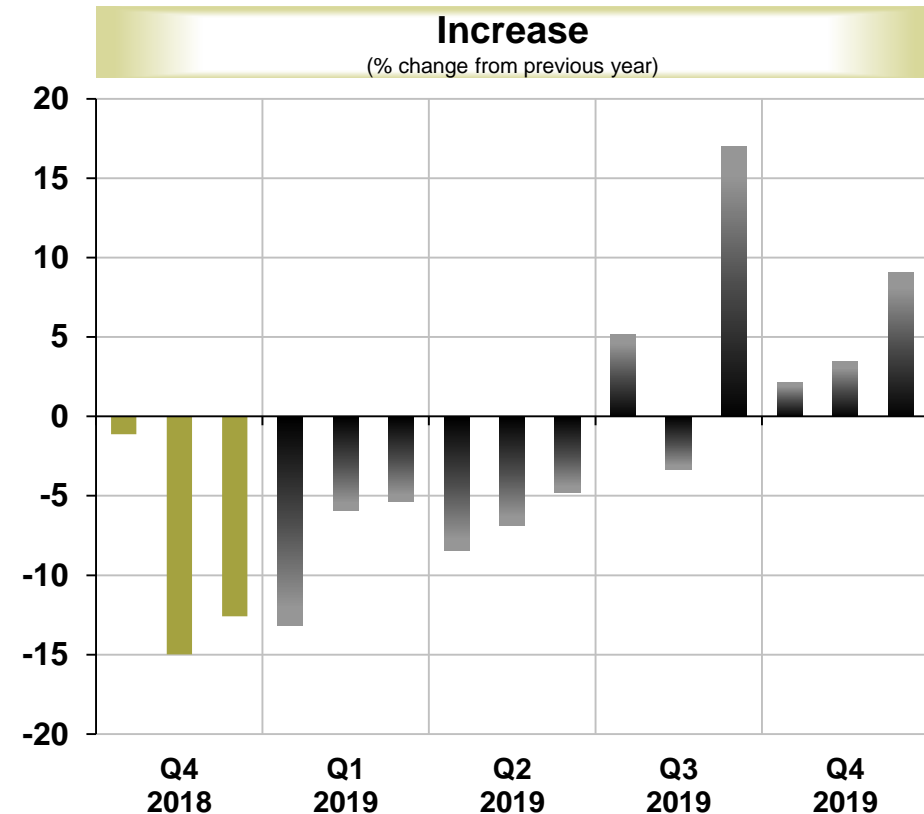

2,928	~ 3,206	~ 3,270	~ 2,804	~ 3,057
- 9.7 %	- 8.0 %	- 6.7 %	7.3 %	4.4 %

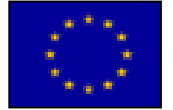

Europe

Flat rolled products | shipments

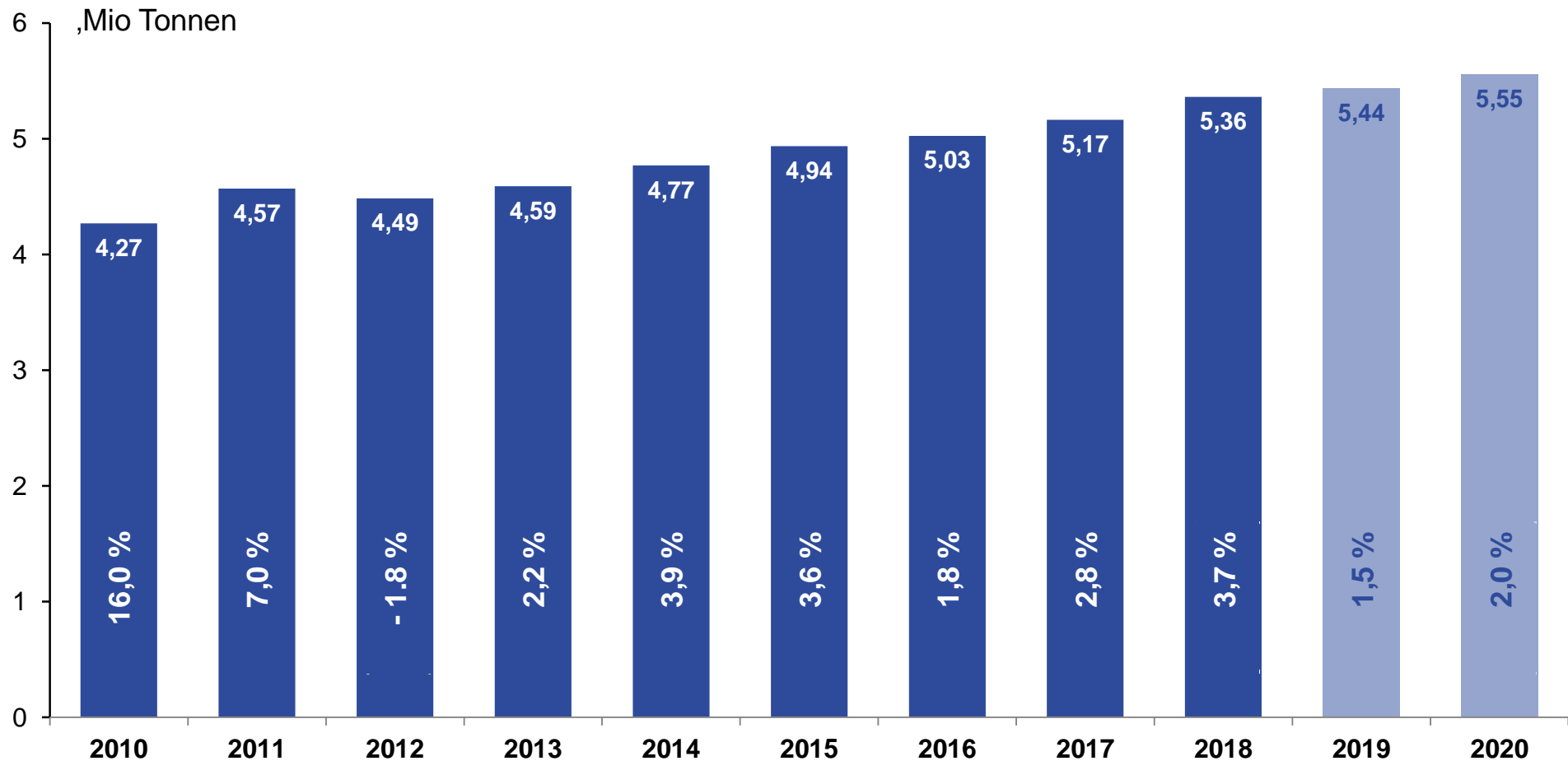



Europe

Extruded products | shipments

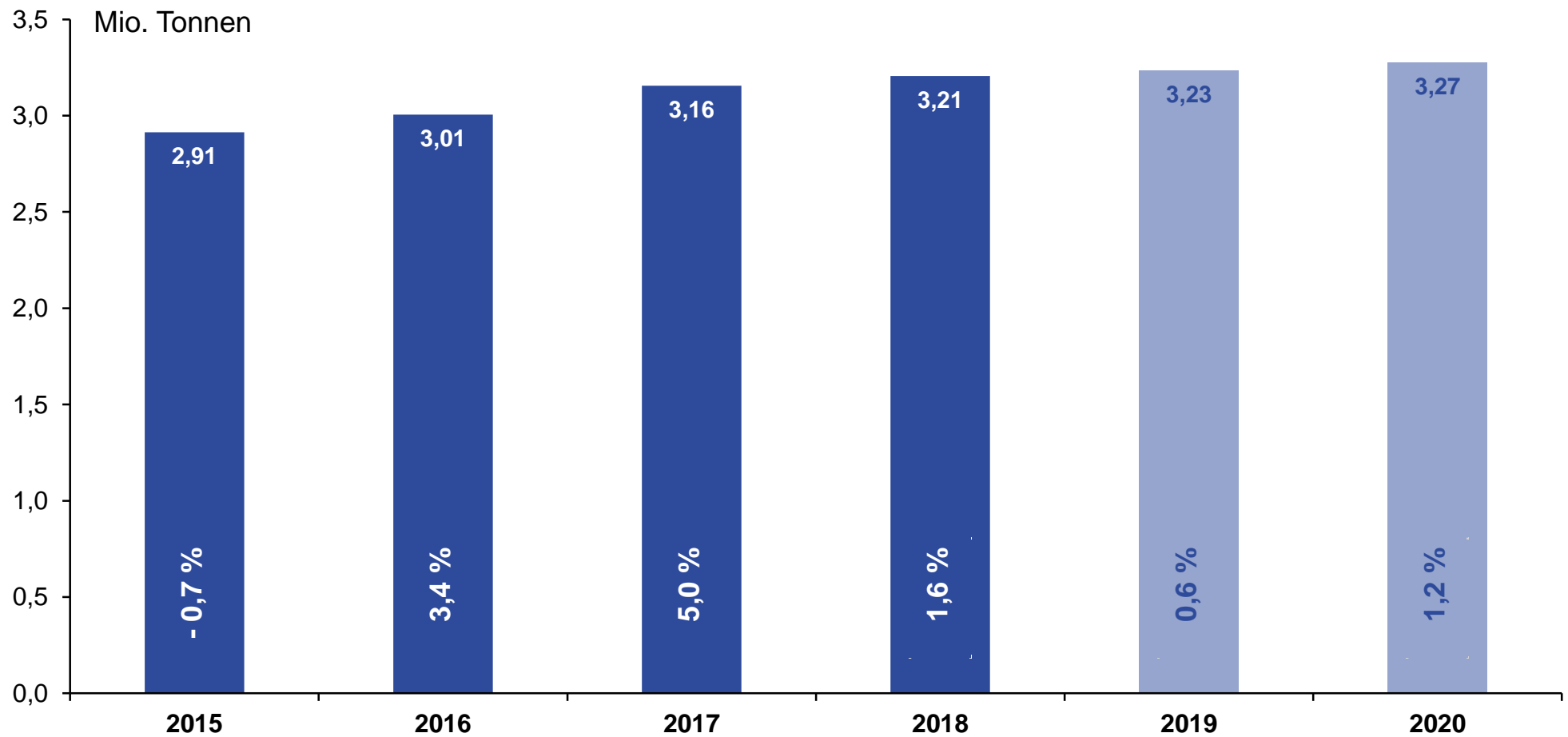



GESAMTVERBAND DER
ALUMINIUMINDUSTRIE e.V.

Aluminium markets – current developments and challenges

Contents

1. Introduction
2. Motivation
3. European demand for semi-fabricated products
4. Aluminium trade
5. Summary

USA

Importe aus China | 5-Jahresvergleich

Rohaluminium

2011: 740 t
2016: 1.424 t

x 2

Walzhalbzeug

2011: 123.701 t
2016: 362.142 t

x 2,9

Aluminiumpulver

2011: 223 t
2016: 3.400 t

x 17

Aluminiumfolie

2011: 77.924 t
2016: 168.501 t

x 2,2

Aluminiumdraht

2011: 1.712 t
2016: 2.916 t

x 1,7

Strangpressprodukte

2011: 8.518 t
2016: 10.759 t

x 1,3

Gesamt

2011: 212.818 t
2016: 549.124 t

x 2,6





GESAMTVERBAND DER
ALUMINIUMINDUSTRIE e.V.



Europa

Importe aus China | 5-Jahresvergleich

Rohaluminium

2010: 4.481 t
2015: 6.830 t

x 1,5

Walzhalbzeug

2010: 54.632 t
2015: 215.081 t

x 3,9

Aluminiumpulver

2010: 361 t
2015: 890 t

x 2,5

Aluminiumfolie

2010: 42.135 t
2015: 86.831 t

x 2,1

Aluminiumdraht

2010: 2.027 t
2015: 4.266 t

x 2,1

Strangpressprodukte

2010: 78.698 t
2015: 111.379 t

x 1,4

Gesamt

2010: 182.334 t
2015: 425.277 t

x 2,3



World Economy Economic Situation

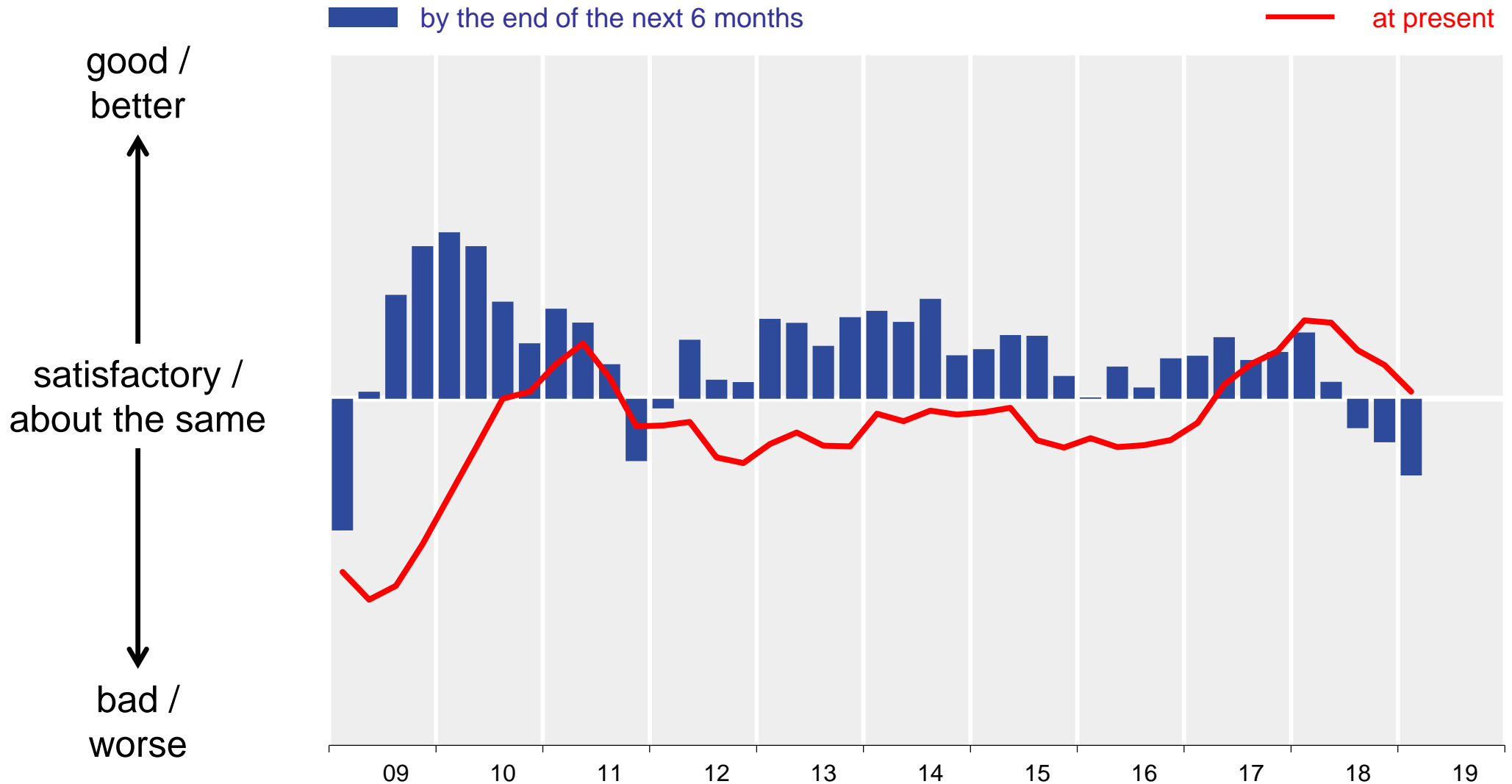

China

Macroeconomic framework

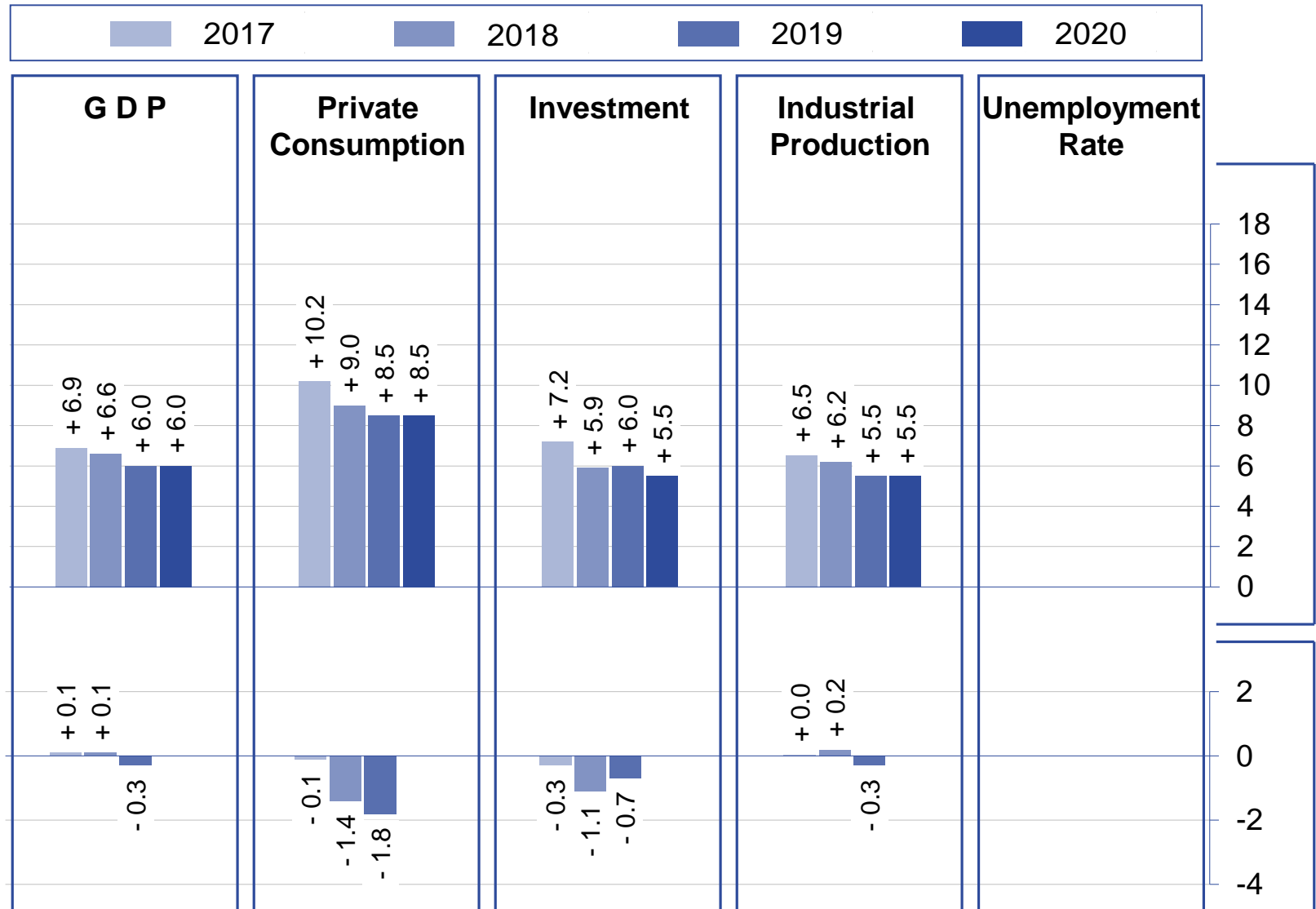
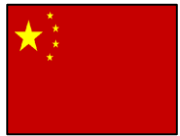

%-change from previous year

State:

02 / 2019

Outlook change (in percentage points)

02 / 2019

vs.

01 / 2018

China

Economic Situation

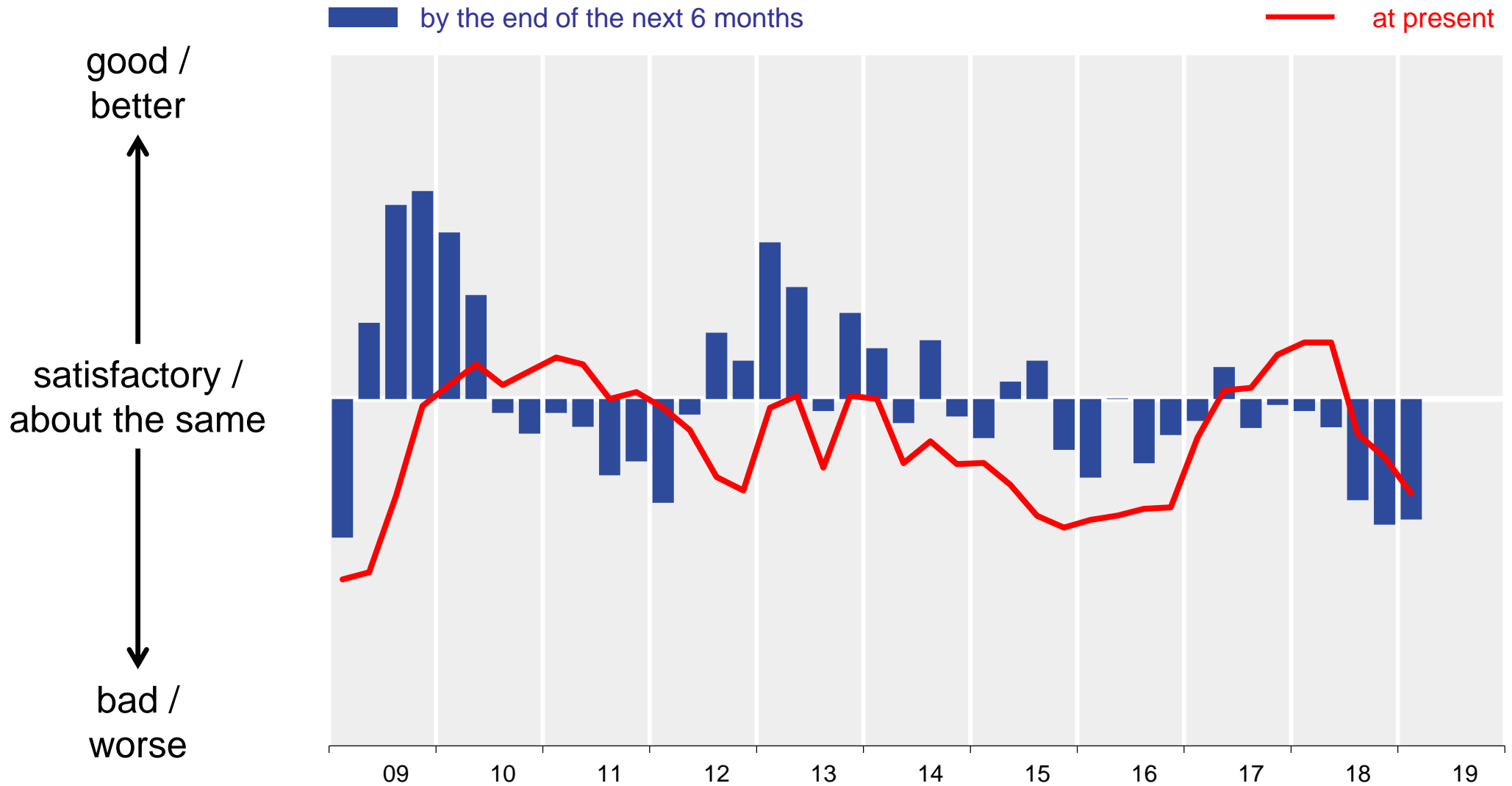

China

Passenger Cars | New Car Registrations (incl. German exports) | Forecast

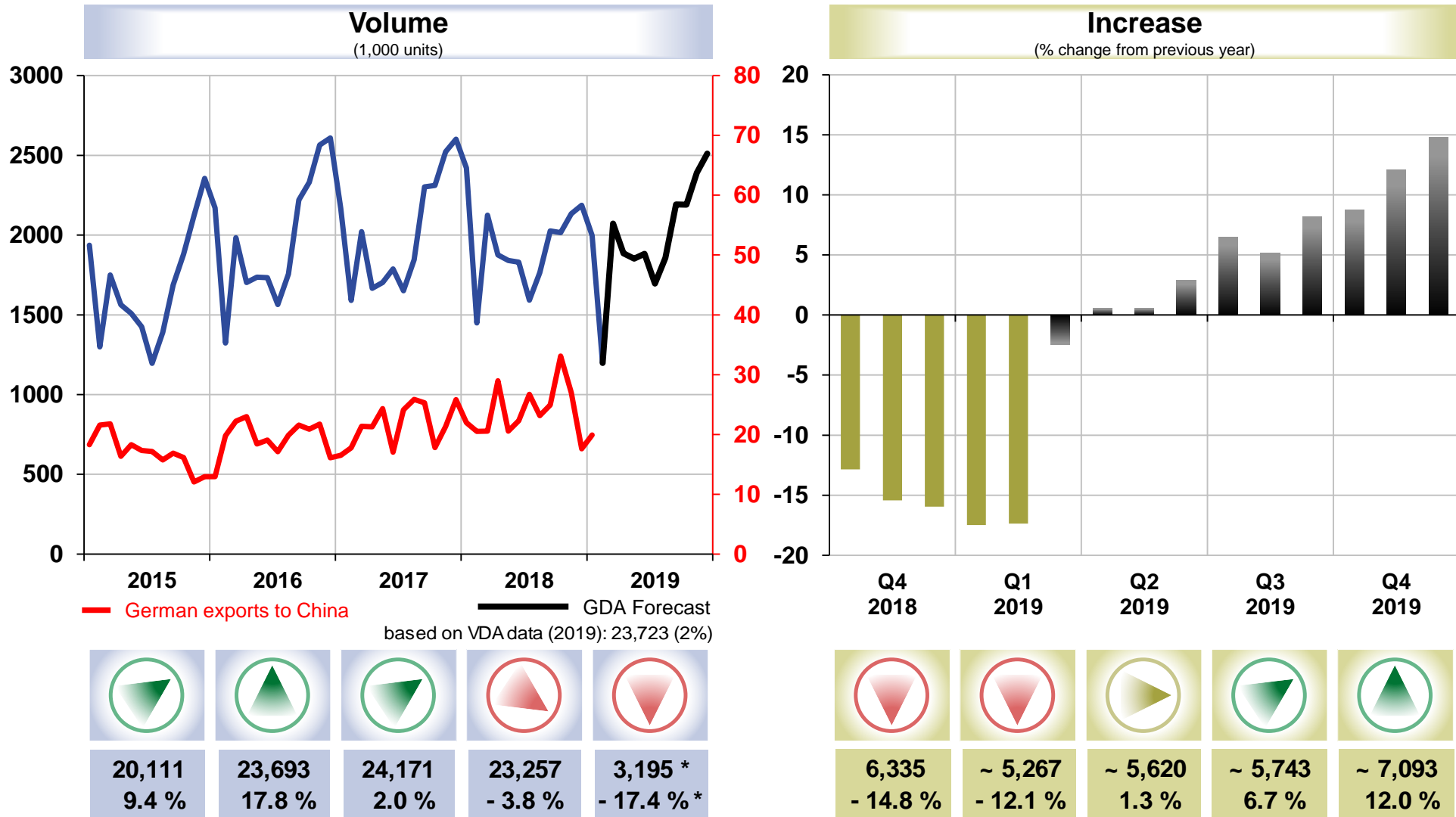

* 01 - 02

Source: VDA | GDA

EU 28

Import & Export | 7606 | Quantity

12. 2018

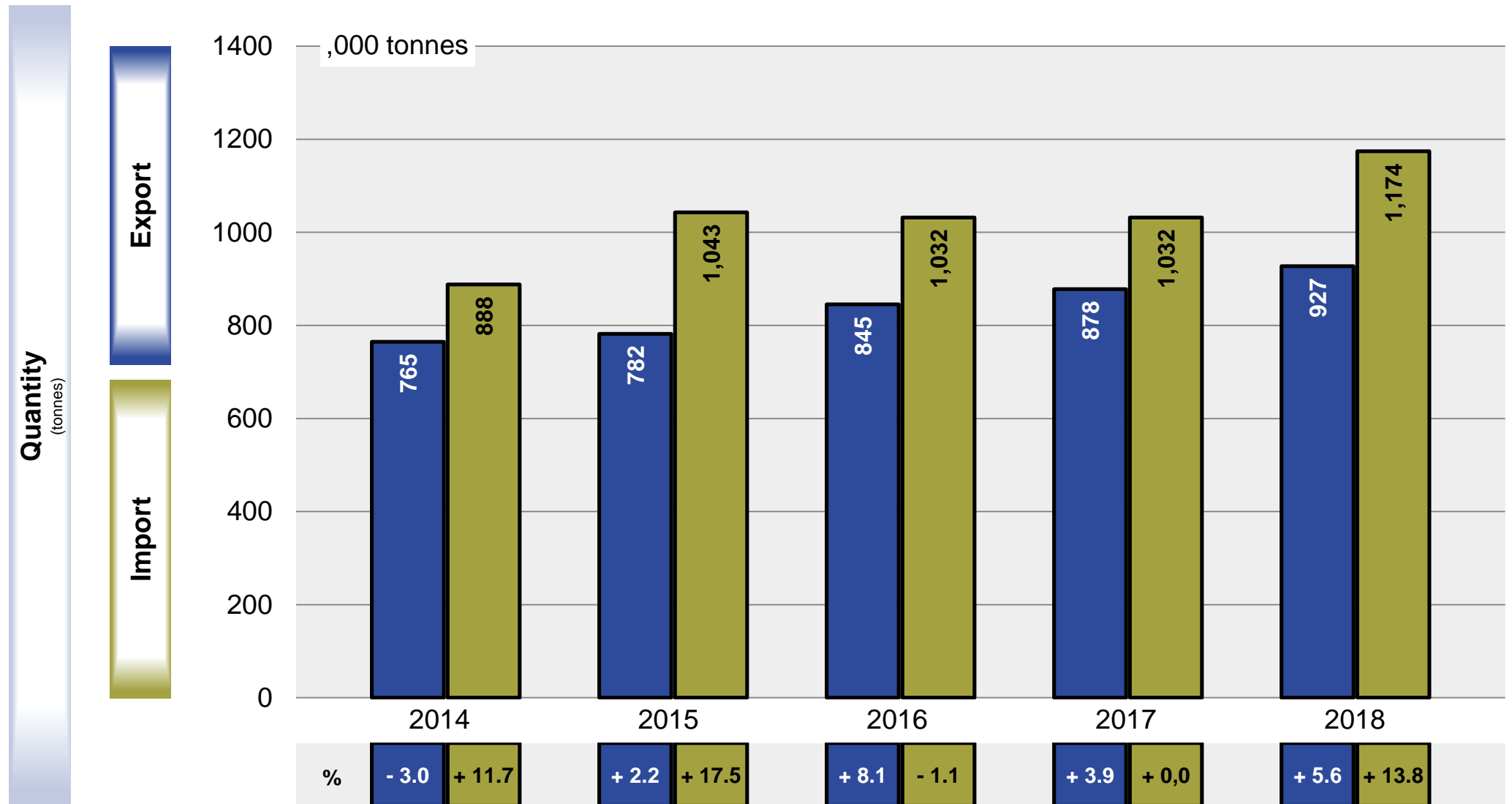

EU 28

Import 2013 - 2018

(Tonnes)

	CAGR	Trend	CAGR	Trend
7606	+ 8,1%		+ 17,2%	
76061110 76061220 <small>(Non-Alloy Aluminium Aluminium Alloys)</small>	+ 10,9%		+ 3,8%	
76061191 76061292 <small>(Non-Alloy Aluminium Aluminium Alloys)</small>	+ 8,9%		+ 53,8%	
76061193 76061293 <small>(Non-Alloy Aluminium Aluminium Alloys)</small>	+ 22,6%		+ 48,1%	
76061199 76061299 <small>(Non-Alloy Aluminium Aluminium Alloys)</small>	+ 4,5%		+ 12,4%	
76069100 76069200 <small>(Non-Alloy Aluminium Aluminium Alloys)</small>	- 2,2%		- 8,5%	

China

Export | 7606 | Quantity

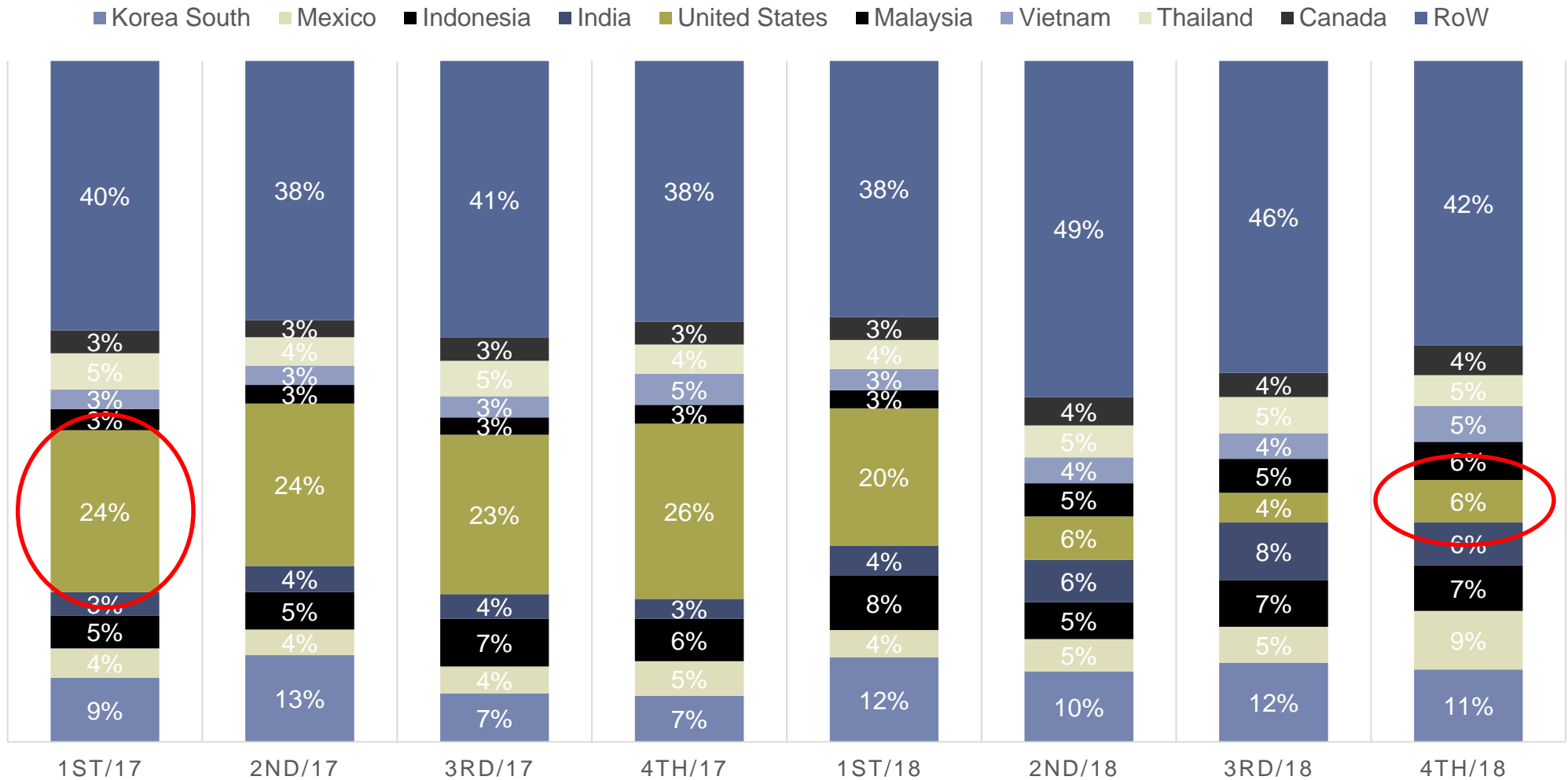

China

Export | 7606 | Quantity in tonnes

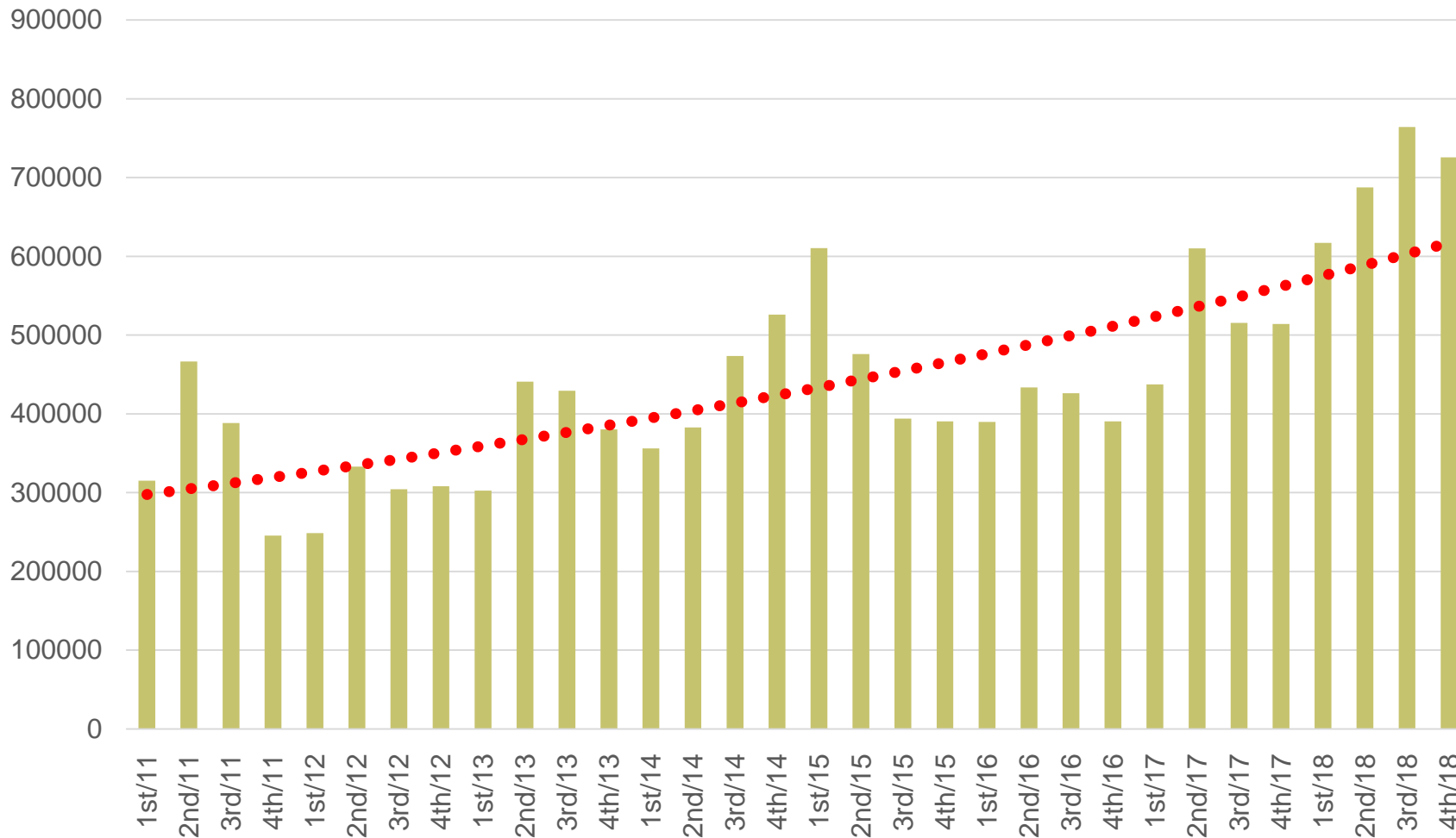



China

Export | 7606 | Quantity in tonnes

	4th/17	4th/18	Delta
Korea South	34,722	77,081	42,359
Turkey	12,440	17,749	5,309
South Africa	3,661	5,028	1,367
Egypt	1,978	3,248	1,270
Serbia	8	44	36
total	52,809	103,150	50,341

EU 28

Import | 7606 | Quantity | Growth and Decline

12. 2018



01 17 02 03 04 05 06 07 08 09 10 11 12 17 - vs - 01 18 02 03 04 05 06 07 08 09 10 11 12 18

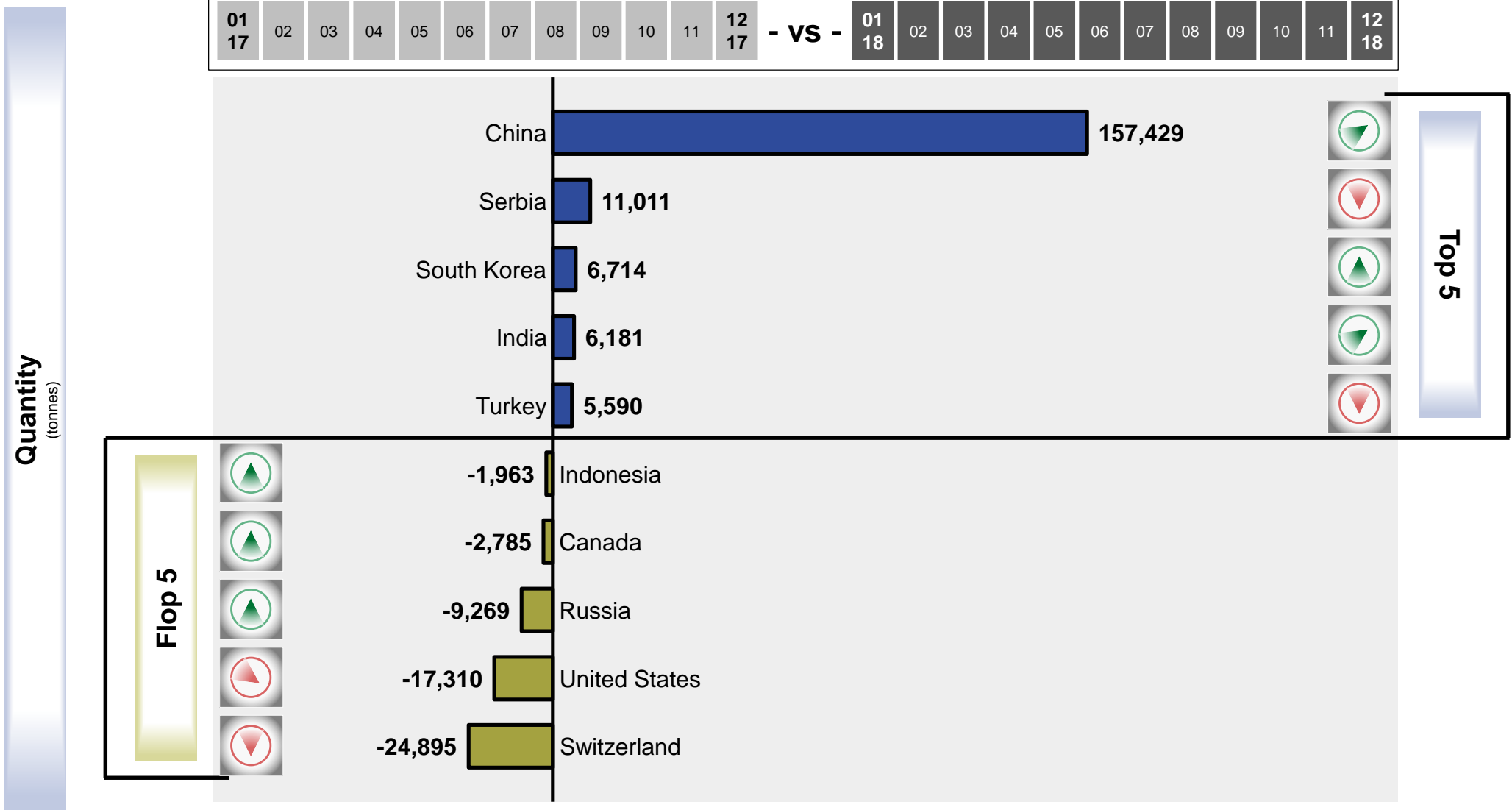

EU 28

Import | 7606 | Quantity

12. 2018

Pos. (Y-D '17)	Share	World	Y - D	± %	12. 18	±% 11. 18	±% 12. 17	3-Y. Max/Min	
			1,174,334	14%	80,228	- 16%	15%	122,443	62,748
1 (3)	25%	China	296,986	113%	26,071	15%	217%	47,812	8,033
2 (1)	23%	Switzerland	275,360	- 8%	15,478	- 23%	- 28%	33,662	12,416
3 (2)	13%	Turkey	151,827	4%	8,615	- 39%	- 16%	15,897	8,615
4 (4)	12%	Norway	137,868	- 1%	8,138	- 31%	- 15%	14,633	6,805
5 (5)	5%	Russia	62,181	- 13%	4,416	12%	- 22%	9,906	1,948
...									

Quantity
(tonnes)

EU 28

Import | 7606 | Quantity

12.

2018



Pos. (Y-D '17)	Share	World	Y - D	± %	12. 18	±% 11. 18	±% 12. 17	3-Y. Max/Min	
			1,174,334	14%	80,228	- 16%	15%	122,443	62,748
6 (6)	5%	Egypt	53,638	1%	3,460	- 15%	- 22%	6,709	919
7 (9)	4%	Serbia	46,138	31%	1,683	- 55%	- 8%	5,301	1,594
8 (8)	3%	South Africa	38,159	3%	2,111	- 55%	- 6%	4,974	1,549
9 (7)	3%	United States	33,260	- 34%	1,926	- 22%	- 40%	16,986	1,926
10 (11)	2%	South Korea	21,012	47%	3,699	50%	228%	3,699	284
11 - 55	< 5%	...							

Quantity
(tonnes)

EU 28

Total imports vs Imports from China

Monthly (Tonnes)

Plates, Sheets and Strip, >= 6 mm

Square or Rectangular

(Excl. such Products Painted, Varnished or Coated with Plastics, and Expanded Plates, Sheets and Strip)

Commodity: 76061199 & 76061299

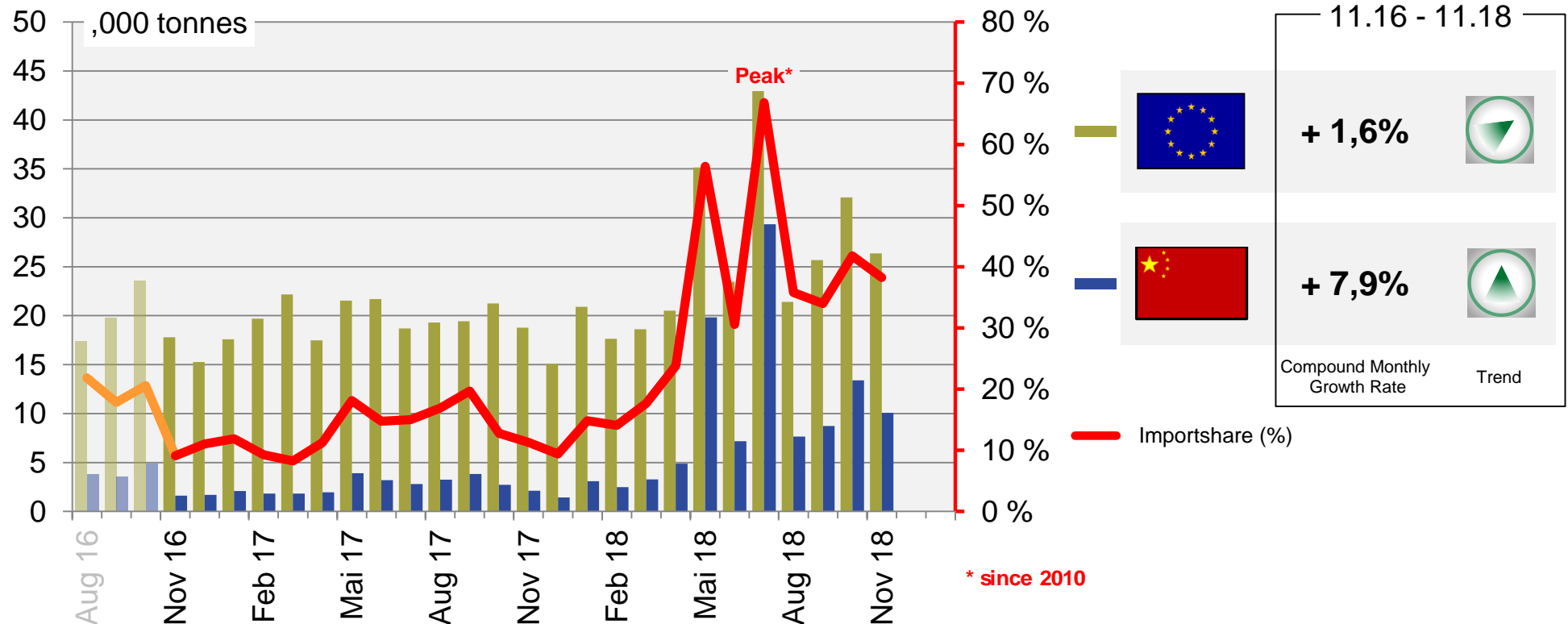

* since 2010

EU 28

Total imports vs Imports from China

Monthly (Euro)

Plates, Sheets and Strip, ≥ 6 mm

Square or Rectangular

(Excl. such Products Painted, Varnished or Coated with Plastics, and Expanded Plates, Sheets and Strip)

Commodity: 76061199 & 76061299

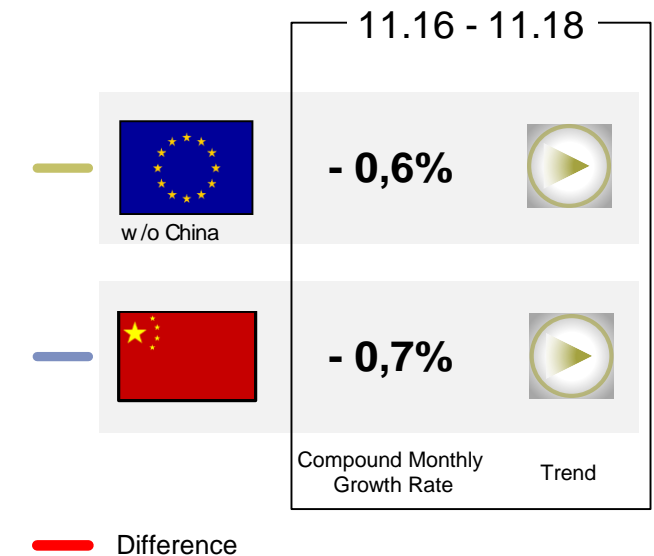
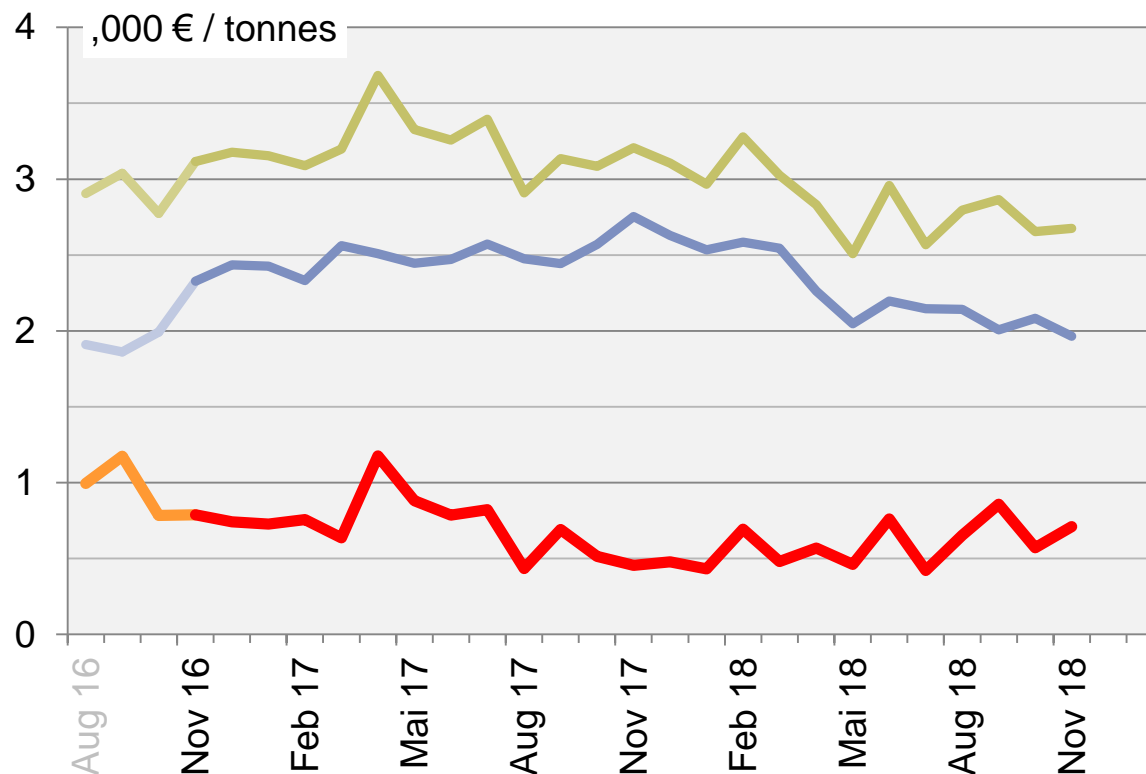

EU 28

Export | 7606 | Quantity | Growth and Decline

12. 2018



01 17 02 03 04 05 06 07 08 09 10 11 12 17 - vs - 01 18 02 03 04 05 06 07 08 09 10 11 12 18

Quantity (tonnes)

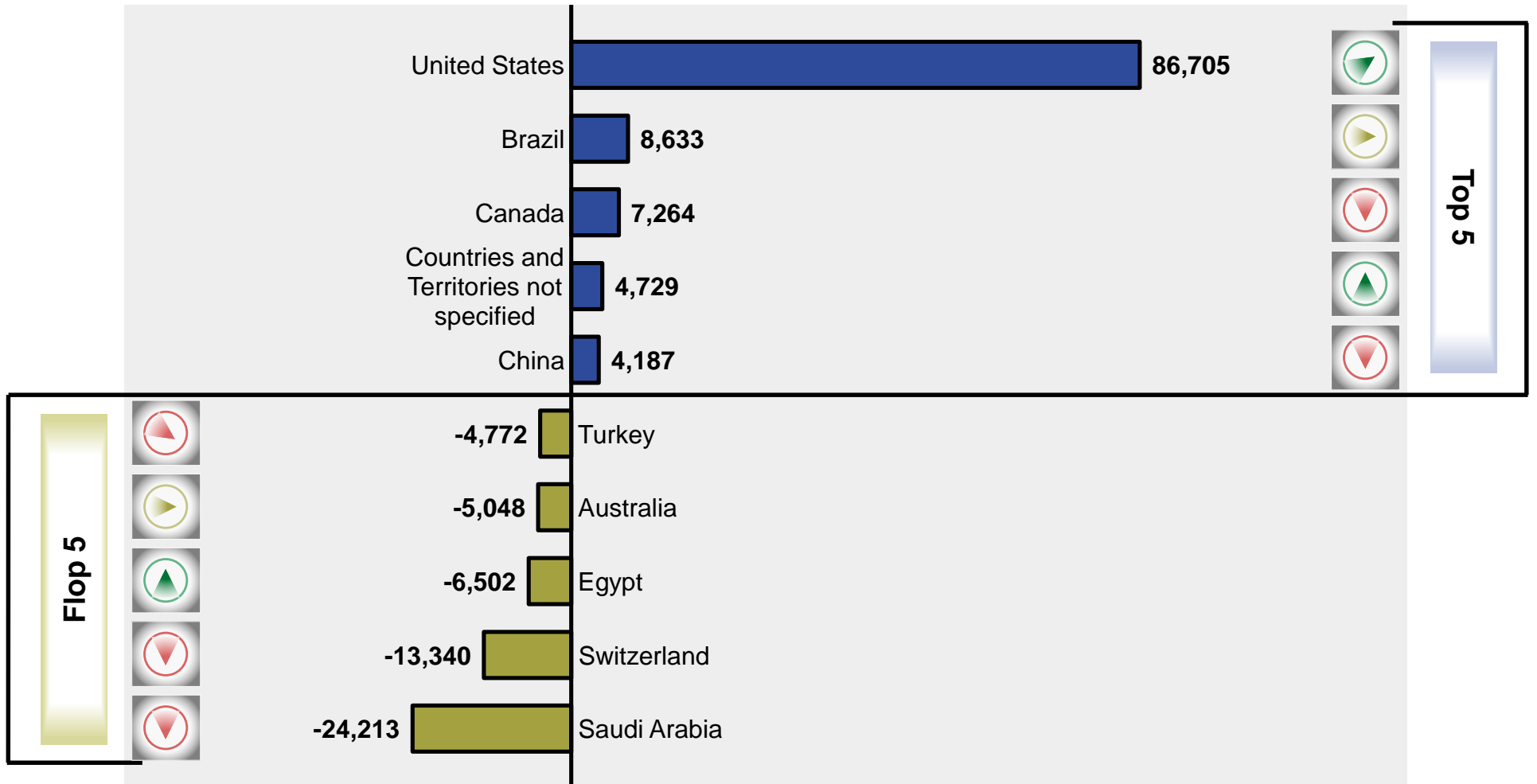

EU 28

Export | 7606 | Quantity

12.

2018



Pos. (Y-D '17)	Share	World	Y - D	± %	12. 18	±% 11. 18	±% 12. 17	3-Y. Max/Min	
			926,645	5%	67,515	- 11%	3%	88,188	57,008
1 (1)	27%	United States	251,027	53%	24,944	- 2%	83%	28,925	10,225
2 (2)	15%	Switzerland	143,487	- 9%	6,576	- 45%	- 32%	15,273	4,496
3 (3)	9%	Turkey	85,214	- 5%	5,386	7%	- 24%	9,420	5,021
4 (4)	5%	Mexico	48,403	3%	3,272	- 13%	2%	5,102	1,399
5 (7)	4%	China	37,833	12%	1,790	- 45%	- 23%	4,307	1,790
		...							

Quantity
(tonnes)



EU 28 Export | 7606 | Quantity

12. 2018









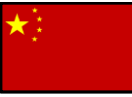
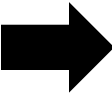

Pos. (Y-D '17)	Share	World	Y - D	± %	12. 18	±% 11. 18	±% 12. 17	3-Y. Max/Min	
			926,645	5%	67,515	- 11%	3%	88,188	57,008
6 (6)	4%	South Africa	37,534	2%	1,518	81%	- 55%	4,730	349
7 (8)	3%	South Korea	30,032	- 5%	1,896	- 20%	- 19%	3,589	1,896
8 (13)	3%	Brazil	27,973	45%	2,157	- 3%	37%	3,652	765
9 (11)	3%	Canada	27,434	36%	1,275	- 39%	- 1%	6,361	1,275
10 (9)	3%	Serbia	24,223	- 16%	2,307	26%	- 24%	3,880	1,349
11 - 153	< 23%	...							

Quantity
(tonnes)

EU 28

Import 2013 - 2018

(Tonnes)

			  	
	CAGR	Trend	CAGR	Trend
Aluminium Extruded Products*	+ 8,3%		+ 15,5%	
7604 (Aluminum Bars, Rods and Profiles)	+ 8,1%		+ 14,6%	
7608 (Aluminum Tubes And Pipes)	+ 4,9%		+ 27,6%	

*Aluminum Bars, Rods and Profiles, Tubes (minus welded Tubes)

EU 28

Total imports vs Imports from China

Quarterly (Tonnes)

Aluminium Extruded Products

Aluminum Bars, Rods and Profiles, Tubes (minus welded Tubes)

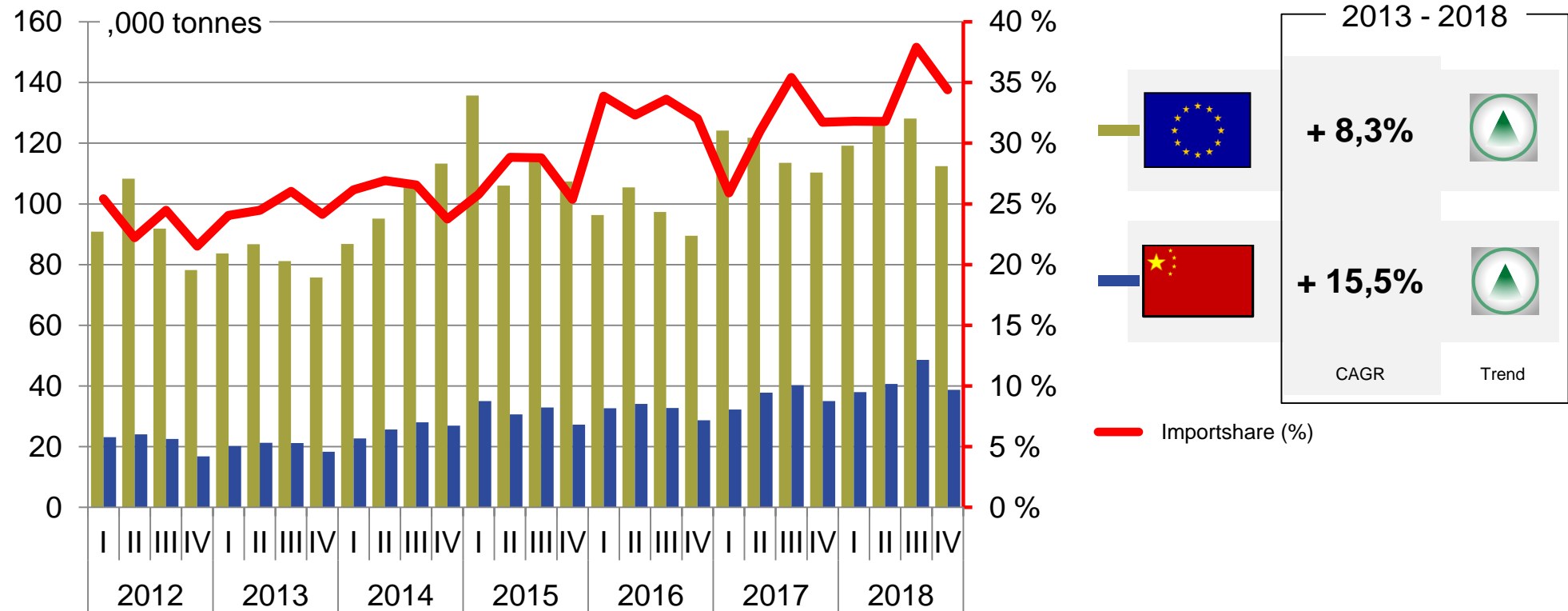



GESAMTVERBAND DER
ALUMINIUMINDUSTRIE e.V.

Aluminium markets – current developments and challenges

Contents

1. Introduction
2. Motivation
3. European demand for semi-fabricated products
4. Aluminium trade
5. Summary



Your contact



Dr. Andreas Postler
Head of Economics and Statistics

GDA – Gesamtverband der Aluminiumindustrie e.V.
Fritz-Vomfelde-Str. 30
40547 Düsseldorf
Tel. 0211 – 47 96 – 118
andreas.postler@aluinfo.de



www.aluinfo.de



www.facebook.com/aluverband



<http://tinyurl.com/GDA-YouTube>



www.twitter.com/aluverband



www.instagram.com/aluverband



www.xing.to/aluverband



www.linkedin.com/company/aluverband